



**apparecchio di illuminazione da incasso per interni ed esterni.
composto da un corpo cilindrico diametro Ø25mm/1" h.35mm/1.4" in alluminio ossidato e
da borchie tonde a battuta o scomparsa totale.**

modelli:

**zero4 led spot disponibile con ottiche intercambiabili 11° 18° 30° 43° o ellittica 9°x48°,
zero4 led side emitter luce diffusa.**

cablato con sorgente elettronica 3000K o 4000K fino a 1,5W 121lm.

accessori: cassaforme incasso laterizio, ghiera e molle di fissaggio.

finiture: corpo nero55, borchie argento opaco e polimetilmetacrilato satinato.

recessed light fitting for indoor and outdoor use.

**it consists of a diameter Ø25mm/1" h.35mm/1.4" oxidised aluminium cylindrical body and
round bezels with rebate or totally concealed.**

versions:

**zero4 led spot is available wet location rated with 11° 18°43° optics or 9°x48° elliptical
interchangeable optics,**

zero4 side emitter damp location rated with diffused light.

wired with 3000K or 4000K led source up to 1.5W 121lm.

accessories: recessed brick housings, fixing ring nut and springs.

finishes: nero55 fitting, matt silver and satin polymethyl methacrylate bezels.

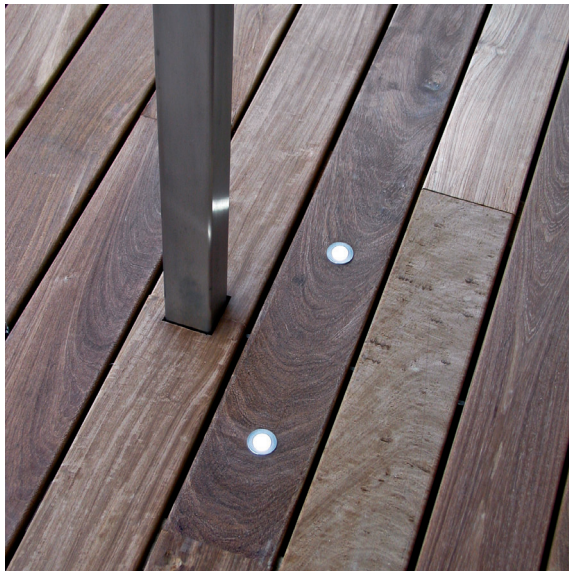



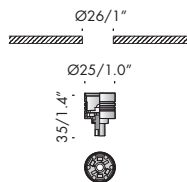

zero4 led spot		wet		i					
f6.164.07	nero55	3000K	30°	0,1kg	0.2lb				
Ra	ies tm-30		sdc	mA	V _{f (min)}	lm	W	lm/W	
90	Rf 90	Rg 100	step 2	500	2,9	104	1,5	69	A++
ca001	les2	Ta25 °C	vita media · average life		50000 h	L80	B10		

f6.164.06 nero55 4000K 30° 0,01kg
0.02lb

Ra	ies tm-30		sdc	mA	V _{f (min)}	lm	W	lm/W	
90	Rf 83	Rg 96	step 2	500	2,9	121	1,5	81	A++
ca003	les2	Ta25 °C	vita media · average life		50000 h	L80	B10		



cavi con connettore. cables with connector.		i		
f9.164.86	2000mm	0,01kg	78.7"	0.02lb
f9.164.87	5000mm	0,01kg	196.8"	0.02lb
f9.164.88	10000mm	0,01kg	393.7"	0.02lb
F9.164.86.U	Special angle low profile cord for shallow install			



borchie. bezels.		i	
f9.164.73	tonda in alluminio con serraggio viti round aluminium with screws fixing	0,01kg	0.02lb
f9.163.71	scomparsa totale · fully concealed	0,01kg	0.02lb
f9.163.72	con battuta · with trim	0,01kg	0.02lb

11,0,4"
Ø20/0,8"



ottiche zero4 led spot. optics.



f9.164.95	11°	20mm 0.8"	0,01kg 0.02lb
f9.164.96	18°	20mm 0.8"	0,01kg 0.02lb
f9.164.97	43°	20mm 0.8"	0,01kg 0.02lb
f9.164.98	ellittica · elliptic 9°x48°	20mm 0.8"	0,01kg 0.02lb



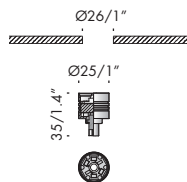

zero4 led side emitter				damp					
f6.164.17	nero55	3000K				0,01kg		0.02lb	
Ra	ies tm-30		sdc	mA	V _{f (min)}	lm	W	lm/W	
90	Rf 83	Rg 96	step 2	500	2,9	121	1,5	81	A++
ca003	les2	Ta25 °C	vita media · average life		50000 h	L80 B10			

f6.164.16	nero55	4000K				0,01kg		0.02lb	
Ra	ies tm-30		sdc	mA	V _{f (min)}	lm	W	lm/W	
90	Rf 90	Rg 100	step 2	500	2,9	104	1,5	69	A++
ca001	les2	Ta25 °C	vita media · average life		50000 h	L80 B10			



cavi con connettore. cables with connector.					
f9.164.86		2000mm	0,04kg	78.7"	0.08lb
f9.164.87		5000mm	0,04kg	196.8"	0.08lb
f9.164.88		10000mm	0,04kg	393.7"	0.08lb

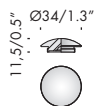

borchie tonde diffondenti. diffusing round bezels.			
f9.164.74	polimetilmetacrilato satinato sanded polymethyl methacrylate	0,02kg 0.04lb	
f9.164.75	polimetilmetacrilato satinato e acciaio sanded polymethyl methacrylate and steel	0,02kg 0.04lb	



alimentatori. power supplies.		120-277V 50-60Hz		damp			
t4.306.u		500mA	2±13V			0,09kg 0.2lb	





cassaforma incasso laterizio. brick housing for recessed body.



f9.164.82 cassaforma per borchia con viti
housing for bezel with screws 0,02kg
0.05lb



f9.164.80.1 cassaforma per borchia senza viti
housing for bezel without screws 0,02kg
0.05lb



f9.164.84 cassaforma per borchia senza viti con foro
housing with hole for bezel without screws 0,02kg
0.05lb



accessori. accessories.



f9.164.83 ghiera per fissaggio da retro
ring nut for fastening from behind 0,02kg
0.05lb



f9.164.81 molle per incasso · springs for recessed 0,001g
0.04 ounce

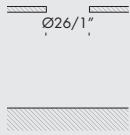

dimensione foro incasso
opening dimensions
for recessed

f9.164.81

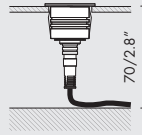

montaggio incasso con molla
springs for recessed

f9.164.83

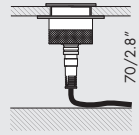

montaggio incasso
con ghiera posteriore
ring nut for fastening
from behind

f9.164.82

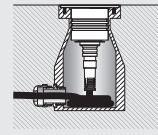

montaggio con
cassaforma laterizio IP67
brick housing for
recessed body IP67

f9.164.84

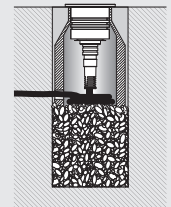

montaggio con
cassaforma laterizio
brick housing for
recessed body

cartongesso/legno
plasterboard/wood

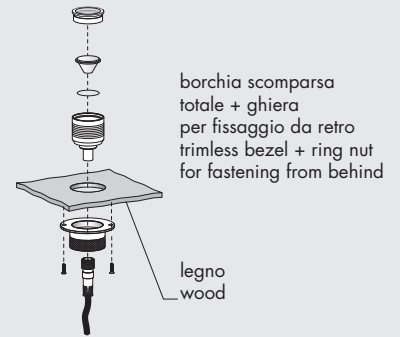
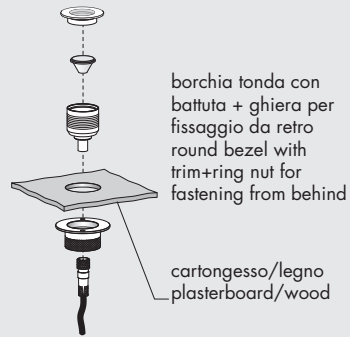
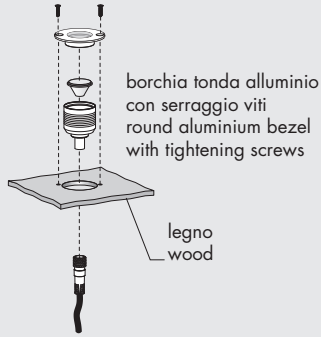

cassaforma laterizio
brick housing

