

4200

4000 SERIES

LUMEN™  
Truss



# 4200 PROFILE

4000 Series

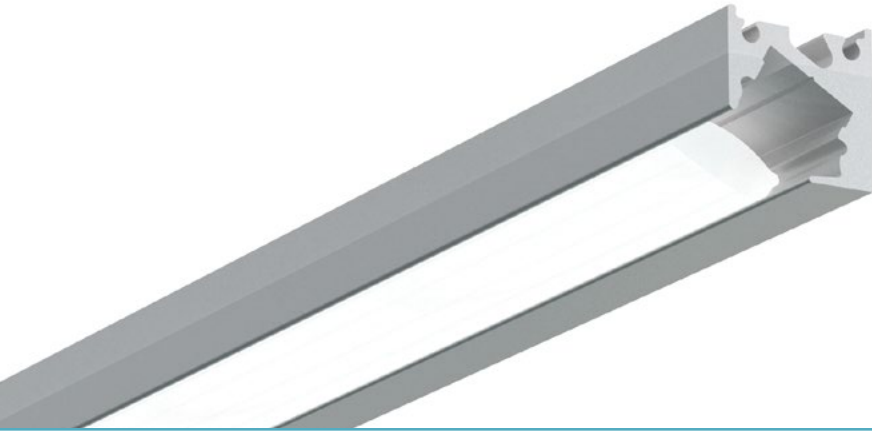

## Cross-section dimensions:

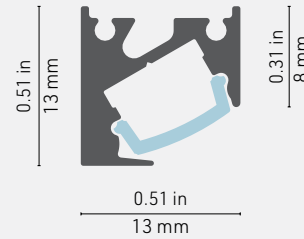

## NEW! ELEGANCE AND DISCRETION

Our range of ultra-compact profiles has been expanded! The 4200 profile provides accent lighting at an angle of 30° to highlight products on shelves or to cut out the underside of cabinets. Compatible with the new SiLens made of flexible silicone, which can be installed at the touch of a finger. A notch on the underside completely conceals the TR64 mounting wire, giving the luminaire an even more aesthetic look. Ideal for commercial or residential applications.

### FEATURES

- Ultra-compact aluminum profile: 13 mm x 13 mm (1/2" x 1/2")
- Custom length from 2 to 240 inches (6 m)
- 30° lighting angle
- 4 lumen packages: LP0 (128 lm/1.5 W/ft), LP1 (160 lm/1.5 W/ft), LP2 (255 lm/3.0 W/ft) and LP3 (308 lm/4.5 W/ft) in a width of 8 mm
- 6 color temperatures (2400 K to 6200 K), CRI 90+
- Compatible with the new SiLens, in flexible silicone
- Notch concealing the TR64 mounting wire
- Surface installation with 3M double-sided tape
- Offered in hardwire only
- Indoor use, IP22
- Designed to meet North American woodworking standards

### OPTIONS

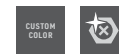

### LED STRIP COMPATIBILITY

Compatible with LED strips up to **8mm** wide.

### LINEAR WEIGHT

0.0442 lbs/ft, 65.83g/m











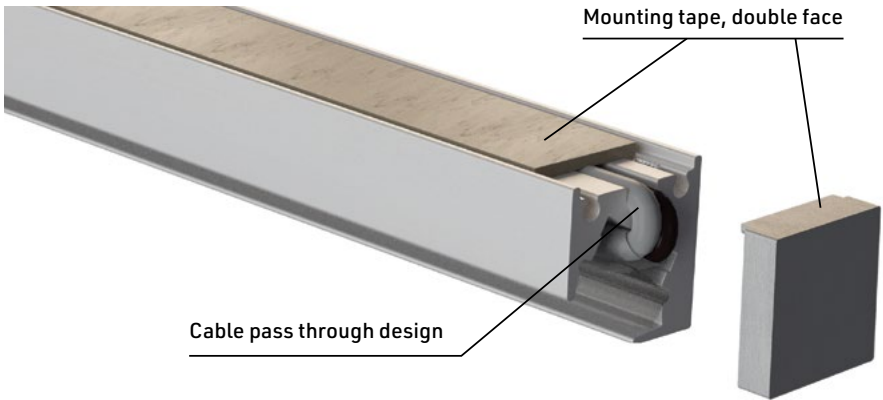



### INTELLIGENT DESIGN

A notch on the underside completely conceals the TR64 mounting wire, giving the luminaire an even more aesthetic look. The encaps are also pass-through and the extrusion has been designed with a recess to insert the mounting tape.



PROFILE	LENSES	MOUNTING HARDWARE	LENGTH
 4200 -Profile, alu	 SIL - SiLens  NO - No lens	 3M - Mounting tape, double face  NO - No mounting hardware	Custom length by sections of 2 to 240 inches (6m).
 4201 -Profile, black			
 4202 - Profile, white			
PROFILE	<div style="border: 1px solid black; padding: 2px; display: inline-block;">SIL</div> LENS	MOUNTING HARDWARE	LENGTH

4000

COLOR TEMPERATURE	LUMEN PACKAGE*	LEAD IN/OUT	USAGE	POWER SUPPLY/CONTROL	*NOTES
<div style="display: flex; flex-direction: column; gap: 5px;"> <div><span style="display: inline-block; width: 15px; height: 10px; background-color: #f4a460; border: 1px solid black;"></span> 24 - 2400K</div> <div><span style="display: inline-block; width: 15px; height: 10px; background-color: #f4c996; border: 1px solid black;"></span> 27 - 2700K</div> <div><span style="display: inline-block; width: 15px; height: 10px; background-color: #f4e1d9; border: 1px solid black;"></span> 30 - 3000K</div> <div><span style="display: inline-block; width: 15px; height: 10px; background-color: #f4f2e1; border: 1px solid black;"></span> 35 - 3500K</div> <div><span style="display: inline-block; width: 15px; height: 10px; background-color: #f4f9e1; border: 1px solid black;"></span> 42 - 4200K</div> <div><span style="display: inline-block; width: 15px; height: 10px; background-color: #f4f9e1; border: 1px solid black;"></span> 62 - 6200K</div> </div>	LP0 - 128 LM / 1.5W FT / 90+CRI LP1 - 160 LM / 1.5W FT / 90+CRI LP2 - 255 LM / 3.0W FT / 90+CRI LP3 - 308 LM / 4.5W FT / 90+CRI	HW3 - Hardwire 3 FT HW6 - Hardwire 6 FT HW9 - Hardwire 9 FT HWX - Hardwire custom FT DC3 - DC plug 3 FT DC6 - DC plug 6 FT DC9 - DC plug 9 FT DCX - DC plug custom FT NO - No lead	I - IP22 indoor dry location	A - Non-dimming B - ELV dimming 120V AC C - ELV dimming 120/277 VAC** D - 0/10V dimming 120/277 VAC E - Non-dimming DC plug in F - DMX G - Lutron - HI-LUME PREMIER 0,1% Eco System 24V/96W I - Casambi CBU-A2D-0/10V-DALI-Bluetooth 100/277 VAC J - Casambi CBU-PWM4-4CH-Bluetooth 100/277 VAC K - Casambi CBU-TED-CV-Trail edge dim-Bluetooth 120 VAC NO - No driver	*The light output is provided in lumens per foot, for a CCT of 4200K and a clear lens. Please refer to the optics page for CCT and translucency conversion factors.  ** Only available in 96W - 24V Driver  <div style="border: 1px solid black; padding: 2px; display: inline-block;">                         TITLE  <span style="font-size: 24px; font-weight: bold;">24</span>  <small>MINIMUM VALUE</small> </div>
COLOR TEMPERATURE CCT	LUMEN PACKAGE	LEAD IN    LEAD OUT	USAGE	POWER SUPPLY/CONTROL	

# NOTES

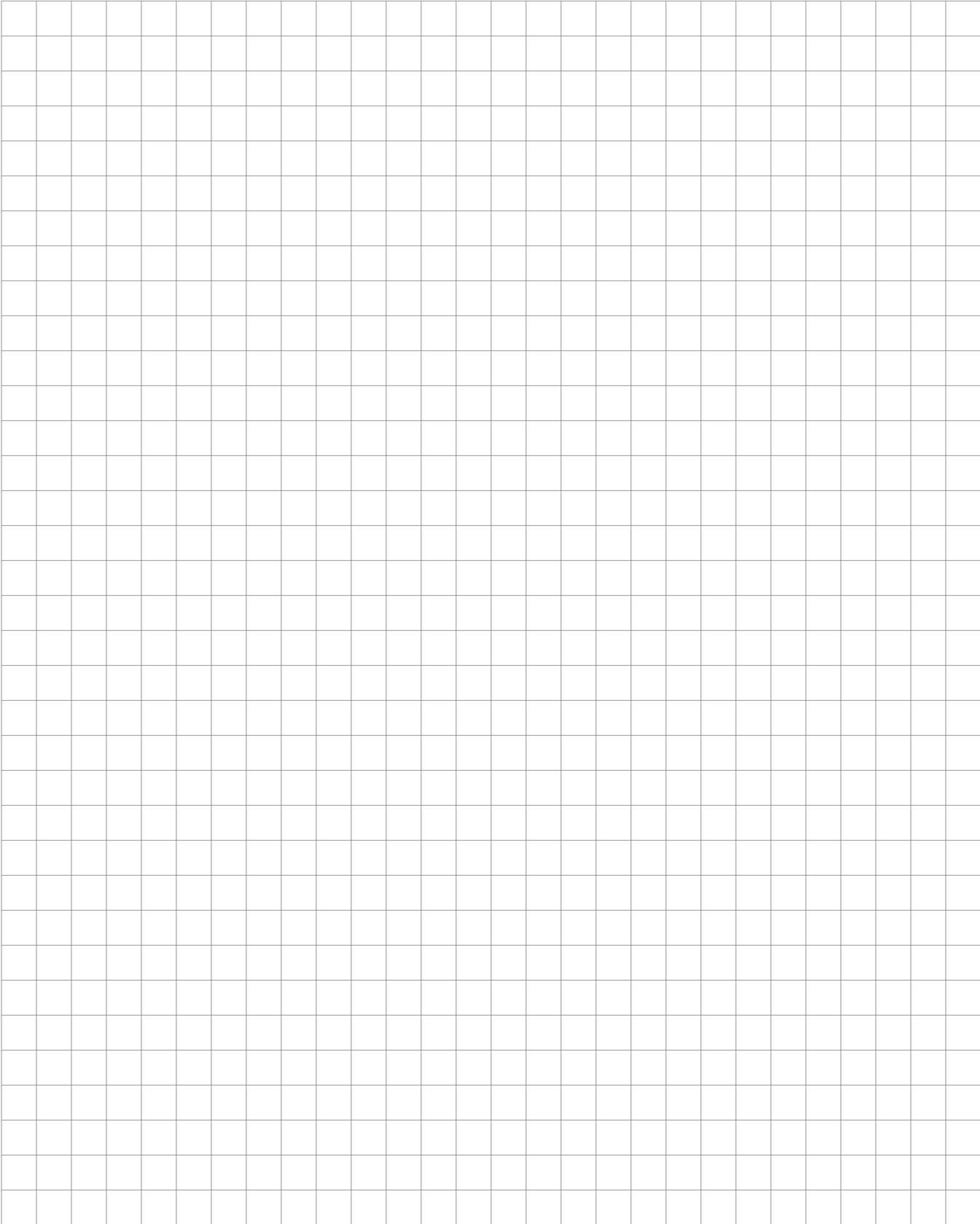



## CONTACT US

### ADDRESS

9221 Edison  
Montreal, Quebec,  
H1J 1T4, Canada

### FAX

1.514.903.0649

### EMAIL

[info@lumentruss.com](mailto:info@lumentruss.com)

### PHONE

1.855.384.3384

### WEBSITE

[www.lumentruss.com](http://www.lumentruss.com)



MADE IN  
NORTH AMERICA

LUMEN™  
Truss